

Una cucina con anta a telaio caratterizzata da un design moderno, che può essere interpretata in una unione perfetta di suggestioni romantiche e tratti minimali. Le essenze sono le più attuali, nelle calde tonalità dei Roveri, dei Frassini e del Noce. Una palette di colori tenui o brillanti, lucidi ed opachi che, abbinata alle ante lisce o decorate, rende Gallery capace di esprimere tutta la sua versatilità. Una rivisitazione moderna di tradizioni antiche per l'anta con la maniglia integrata e la presa stondata, che caratterizza la linea trasformandosi in elemento decorativo, intercambiabile con diversi tipi di maniglie a seconda delle preferenze. Gallery, una cucina senza tempo.

A kitchen with framed doors and a modern design that manages to create a perfect blend of romantic charm and minimal lines. The contemporary wood types are available in warm tones of oak, ash and walnut. Gallery's versatility is expressed by its palette of soft and bright colours available in matt and glossy finishes and with smooth or decorated doors. It represents a modern re-interpretation of old traditions such as the built-in handles with rounded grip; these characterise the shape of the doors and become decorative elements that can be combined with different handles based on your preferences. Gallery, a timeless



CARATTERISTICHE
TECNICHE
TECHNICAL FEATURES

YOUR ROMANTIC HOME

gallery



LUBE ECOLOGIC

IL GRUPPO LUBE HA SCELTO DI UTILIZZARE PER I COMPONENTI COSTITUENTI LE STRUTTURE DELLE CUCINE SOLO MATERIALE A BASSISSIMA EMISSIONE DI FORMALDEIDE: CONFORMI ALLO STANDARD F4STELLE SECONDO LA NORMA JIS, CERTIFICATO DAL MINISTERO GIAPPONESE, IL PIU' SEVERO IN MERITO ALLE NORMATIVE DI SALVAGUARDIA AMBIENTALE.

Regarding the production of its kitchen structure components, lube group has decided to only use materials featuring very low formaldehyde emissions complying with the 4-star standard, as defined by the jis regulation. This standard is certified by the japanese government-the most rigorous when it comes to environmental protection.



cod. **390** impiallacciata a telaio

SP. 24 MM

gallery

CARATTERISTICHE TECNICHE

ANTE

telaio in massello sp. 24 mm impiallacciato con cartella impiallacciata spazzolata fiamma orizzontale nelle finiture : frassino bianco assoluto (opz.2460), frassino corda decapè grigio (opz.2461), frassino bianco decapè argento (opz.2462), frassino fango decapè argento (opz.2463), frassino piombo (opz.2465)

telaio in massello sp. 24 mm impiallacciato con cartella impiallacciata spazzolata fiamma orizzontale nelle finiture: rovere naturale (opz.5371), rovere tabacco decapè (opz.5373), rovere visone decapè (opz.5372)

ANTE VETRO

di serie:

telaio in massello impiallacciato sp. 24 mm nelle finiture:
frassino bianco assoluto (opz.2460B), frassino corda decapè grigio (opz.2461B), frassino piombo (opz.2465B)
frassino bianco decapè argento (opz.2462B), frassino fango decapè argento (opz.2463B), con vetro satinato bianco

telaio in massello impiallacciato sp. 24 mm nelle finiture: rovere naturale (opz.5371B), rovere tabacco decapè (opz.5373B), rovere visone decapè (opz.5372B), con vetro satinato bianco

a richiesta:

telaio in massello impiallacciato sp. 24 mm nelle finiture:
frassino bianco assoluto (opz.2460M), frassino corda decapè grigio (opz.2461M), frassino piombo (opz.2465M)
frassino bianco decapè argento (opz.2462M), frassino fango decapè argento (opz.2463M), con vetro satinato e molato

telaio in massello impiallacciato sp. 24 mm nelle finiture: rovere naturale (opz.5371M), rovere tabacco decapè (opz.5373M), rovere visone decapè (opz.5372M), con vetro satinato e molato

MANIGLIE PER

ANTE: frassino bianco
assoluto, frassino corda
decapè grigio,
rovere naturale,
rovere tabacco decapè,
rovere visone decapè

di serie: 560 finitura cromo passo mm 64/160/320 in funzione dell'anta

a richiesta:

561S finitura cromo profili esterni, interno satinato passo mm 64/160/320 in funzione dell'anta
561T finitura cromo profili esterni, interno tortora passo mm 64/160/320 in funzione dell'anta

563T finitura cromo, interno tortora passo mm 64/160/320 in funzione dell'anta

477 finitura cromo passo mm 64/160/320 in funzione dell'anta
475C finitura cromo passo mm 96/160/320 in funzione dell'anta
475M finitura brown opaco passo mm 96/160/320 in funzione dell'anta
479C finitura cromo passo mm 96/160/320 in funzione dell'anta
479B finitura bianco opaco passo mm 96/160/320 in funzione dell'anta
L maniglia in legno

MANIGLIE PER

ANTE: frassino bianco
decapè argento,
frassino fango
decapè argento

di serie: 565 finitura nikel satinato passo mm 160

a richiesta:

490 finitura argento semilucido passo mm 64/160/320 in funzione dell'anta
421 finitura argento passo mm 16



CARATTERISTICHE TECNICHE

MANIGLIE PER
ANTA: noce nazionale

a richiesta:
218 finitura nichel antico passo mm 128
per anta L 15 pomo finitura nichel antico 218P
270D finitura dorata con swarovski passo mm 32/128 in funzione dell'anta

STRUTTURE

ANTE: frassino bianco, frassino bianco decapè argento

di serie : nobilitato bianco (opz.001) schiena e ripiano bianco (opz.001)

ANTE: frassino corda decapè grigio, frassino fango decapè argento, rovere tabacco decapè,
rovere visone decapè

di serie : nobilitato perla d'oriente (opz.940) schiena e ripiano avorio (opz.930)

ANTA: rovere naturale

di serie : nobilitato rovere sbiancato (opz.025) schiena e ripiano avorio (opz.930)



MENSOLA

di serie: altezza cm 3,8 in laminato perla d'oriente (opz.940), bianco (opz.001), noce guarnieri (opz.050),
devalè gratis (opz.796)

a richiesta: altezza cm 3,8 impiallacciata finitura come ante

ZOCCOLI

di serie: H 15 in pvc ricoperto in melamina colore alluminio satinato (opz.405)

a richiesta: H 15 in pvc ricoperto in melamina, finitura acciaio spazzolato (opz.407),
H 15 in alluminio finitura brill (opz.412), bianco semilucido (opz.A001),
beige semilucido (opz.A444), brown semilucido (opz.A370) vedi magg. accessori pag.201



GALLERY

cod. **390** veneered frame

TH. 24 MM

gallery

TECHNICAL FEATURES

DOORS

solid wood th. 24 mm veneer finished frame with veneer panel with brushed horizontal grain in the following finishes: absolute white ash (code 2460), grey pickled jute ash (code 2461), silver pickled white ash (code 2462), silver pickled mud grey ash (code 2463)

solid wood th. 24 mm veneer finished frame with veneer panel with brushed horizontal grain in the following finishes: natural oak (code 5371), pickled tobacco oak (code 5373), pickled mink oak (code 5372), lead ash (code 2465)

GLASS DOORS

standard:

solid wood veneer finished frame th. 24 mm in the following finishes: absolute white ash (code 2460B), grey pickled jute ash (code 2461B), silver pickled white ash (code 2462B), silver pickled mud grey ash (code 2463B), with white frosted glass

solid wood veneer finished frame th. 24 mm in the following finishes: natural oak (code 5371B), pickled tobacco oak (code 5373B), pickled mink oak (code 5372B), lead ash (code 2465B) with white frosted glass,

on request:

solid wood veneer finished frame th. 24 mm in the following finishes: absolute white ash (code 2460M), grey pickled jute ash (code 2461M), silver pickled white ash (code 2462M), silver pickled mud grey ash (code 2463M), lead ash (code 2465M) with frosted and bevelled glass,

solid wood veneer finished frame th. 24 mm in the following finishes: natural oak (code 5371M), pickled tobacco oak (code 5373M), pickled mink oak (code 5372M), with frosted and bevelled glass

HANDLES FOR

DOORS: absolute white ash, pickled grey jute ash, natural oak, pickled tobacco oak, pickled mink oak

standard: 560 chrome finish, 64/160/320 centre-to-centre distance according to door size

on request:

566 polished chrome finish with satin insert, 160 mm centre-to-centre distance
561S external profile chrome finish, satin interior, 64/160/320 centre-to-centre distance according to door size
561T external profile chrome finish, dove grey interior, 64/160/320 centre-to-centre distance according to door size
563T chrome finish, dove grey interior, 64/160/320 centre-to-centre distance according to door size

477 chrome finish, 64/160/320 centre-to-centre distance according to door size
475C chrome finish, 96/160/320 mm centre-to-centre distance according to door size
475M matt brown finish, 96/160/320 mm centre-to-centre distance according to door size

479C chrome finish, 96/160/320 mm centre-to-centre distance according to door size
479B matt white finish, 96/160/320 mm centre-to-centre distance according to door size
L-type wooden handle

HANDLES FOR

DOORS: silver pickled white ash, silver pickled clay ash

standard: 565 satin nickel finish, 160 mm centre-to-centre distance

on request:

421 silver finish, 16 mm centre-to-centre distance



TECHNICAL FEATURES

HANDLES FOR DOOR: Italian walnut

on request:
218 antique nickel finish 128 mm centre-to-centre distance
for door W 15 antique nickel finish knob hole 218P
270D gold finish with swarovski crystals, centre-to-centre distance mm 32/128 according to door size

STRUCTURES

DOORS: white ash, silver pickled white ash

standard: melamine-coated white (code 001), white back panel and shelf (code 001)

DOORS: grey pickled jute ash, silver pickled mud grey ash, pickled tobacco oak, pickled mink oak

standard: melamine-coated oriental pearl (code 940), ivory back panel and shelf (code 930)

DOOR: natural oak

standard: melamine coated bleached oak (code 025), ivory back panel and shelf (code 930)

SHELF

standard: height 3.8 cm, in oriental pearl laminate (code 940), white (code 001), guarnieri walnut (code 050), devalè with grafis finish (code 796)

on request: height 3.8 cm, veneered with same finish as doors

PLINTHS

standard: height 15 cm, melamine faced PVC with frosted aluminium finish (code 405)

on request: height 15 cm, melamine faced PVC with brushed steel finish (code 407)

height 15 in brill-finish aluminium (code 412), semi-polished white (code A001),
semi-polished beige (code A444), semi-polished brown (code A370) see accessories surcharges page 201

SP. 24 MM

ante doors



frassino bianco assoluto (opz.2460)
absolute white ash
(code 2460)



cassetto frassino bianco assoluto (opz.2460)
absolute white ash drawer
(code 2460)

cestone frassino bianco assoluto (opz.2460)
absolute white ash deep drawer
(code 2460)

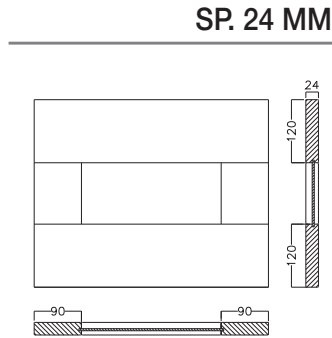

maniglia in legno finitura frassino bianco assoluto (opz.L2460)
wooden handle finished absolute white ash (code L2460)
Note: see surcharge page 49

di serie: ante con vetro satinato bianco standard: doors with white frosted glass



frassino bianco assoluto (opz.2460B)
absolute white ash
(code 2460B)



cestone vetro frassino bianco assoluto (opz.2460B)
absolute white ash glass deep drawer (code 2460B)

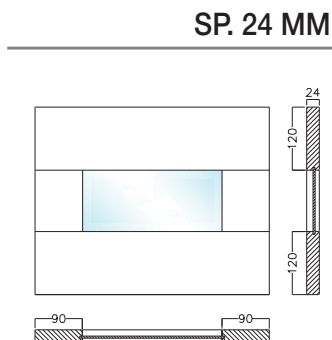

maniglia in legno finitura frassino bianco assoluto (opz.L2460)
wooden handle finished absolute white ash (code L2460)
Note: see surcharge page 49

a richiesta: ante con vetro satinato e molato on request: doors with frosted and bevelled glass



frassino bianco assoluto (opz.2460M)
absolute white ash
(code 2460M)



cestone vetro frassino bianco assoluto (opz.2460M)
absolute white ash glass deep drawer (code 2460M)

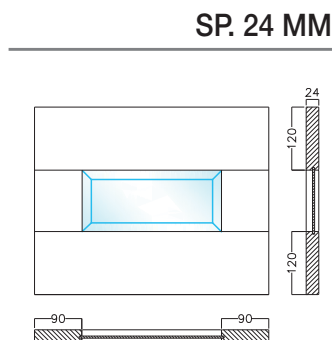

N.B.: CON IL VETRO SATINATO E MOLATO NON SI PUO' INSERIRE LA MANIGLIA "L" IN LEGNO

Note: the "L"-type wooden handle cannot be inserted with the frosted and bevelled glass

cod. **390** impiallacciata a telaio
veneered frame

 colore in pronta consegna
available colour

gallery

SP. 24 MM

ante doors



frassino corda decapè grigio (opz.2461)
pickled grey jute ash
(code 2461)



cassetto frassino corda decapè grigio (opz.2461)
pickled grey jute ash drawer
(code 2461)



cestone frassino corda decapè grigio (opz.2461)
pickled grey jute ash deep drawer
(code 2461)

SP. 24 MM

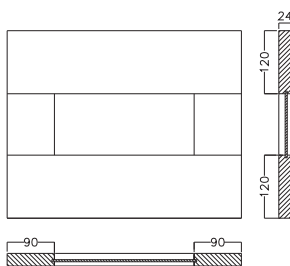

maniglia in legno finitura frassino corda decapè grigio (opz.L2461)
wooden handle finished
pickled grey jute ash (code L2461)
Note: see surcharge page 49

di serie: ante con vetro satinato bianco standard: doors with white frosted glass



frassino corda decapè grigio (opz.2461B)
pickled grey jute ash
(code 2461B)



cestone vetro frassino corda decapè (opz.2461B)
pickled grey jute ash glass
deep drawer (code 2461B)

SP. 24 MM

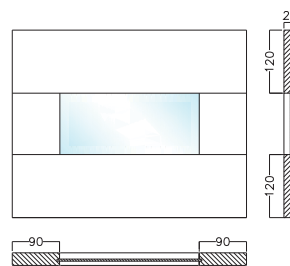

maniglia in legno finitura frassino corda decapè grigio (opz.L2461)
wooden handle finished
pickled grey jute ash (code L2461)
Note: see surcharge page 49

a richiesta: ante con vetro satinato e molato on request: doors with frosted and bevelled glass



frassino corda decapè grigio (opz.2461M)
pickled grey jute ash
(code 2461M)



cestone vetro frassino corda decapè (opz.2461M)
pickled grey jute ash glass
deep drawer (code 2461M)

SP. 24 MM

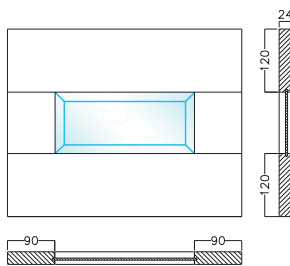

N.B.: CON IL VETRO SATINATO E MOLATO NON SI PUO' INSERIRE LA MANIGLIA "L" IN LEGNO

Note: the "L"-type wooden handle cannot be inserted with the frosted and bevelled glass

cod. **390** impiallacciata a telaio
veneered frame

gallery

SP. 24 MM

ante doors



frassino bianco decapè argento (opz.2462)
pickled silver white ash
(code 2462)



cassetto frassino bianco decapè argento (opz.2462)
pickled silver white ash
drawer (code 2462)



cestone frassino bianco decapè argento (opz.2462)
pickled silver white ash deep
drawer (code 2462)

SP. 24 MM

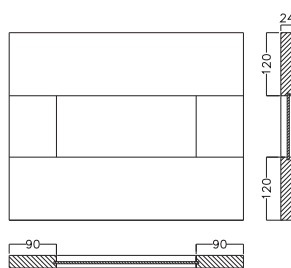

di serie: ante con vetro satinato bianco standard: doors with white frosted glass



frassino bianco decapè argento (opz.2462B)
pickled silver white ash
(code 2462B)



cestone vetro frassino bianco decapè argento (opz.2462B)
pickled silver white ash glass
deep drawer (code 2462B)

SP. 24 MM

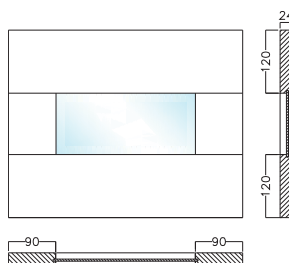

a richiesta: ante con vetro satinato e molato on request: doors with frosted and bevelled glass



frassino bianco decapè argento (opz.2462M)
pickled silver white ash
(code 2462M)



cestone vetro frassino bianco decapè argento (opz.2462M)
pickled silver white ash glass
deep drawer (code 2462M)

SP. 24 MM

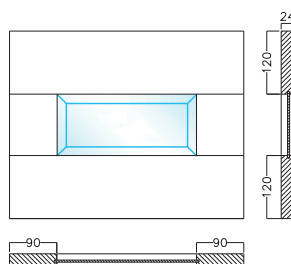

cod. **390** impiallacciata a telaio
veneered frame

gallery

SP. 24 MM

ante doors



frassino fango decapè argento (opz.2463)
pickled silver mud grey ash (code 2463)



cassetto frassino fango decapè argento (opz.2463)
pickled silver mud grey ash drawer (code 2463)



cestone frassino fango decapè argento (opz.2463)
pickled silver mud grey ash deep drawer (code 2463)

SP. 24 MM

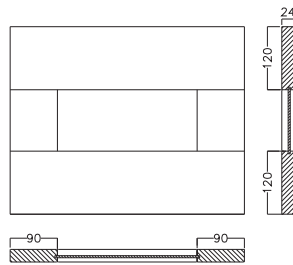

di serie: ante con vetro satinato bianco standard: doors with white frosted glass



frassino fango decapè argento (opz.2463B)
pickled silver mud grey ash glass (code 2463B)



cestone vetro frassino fango decapè argento (opz.2463B)
pickled silver mud grey ash glass deep drawer (code 2463B)

SP. 24 MM

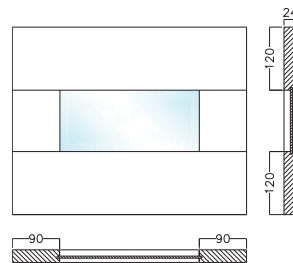

a richiesta: ante con vetro satinato e molato on request: doors with frosted and bevelled glass



frassino fango decapè argento (opz.2463M)
pickled silver mud grey ash glass (code 2463M)



cestone vetro frassino fango decapè argento (opz.2463M)
pickled silver mud grey ash glass deep drawer (code 2463M)

SP. 24 MM

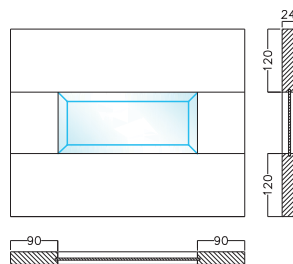

cod. **390** impiallacciata a telaio
veneered frame

gallery

SP. 24 MM

ante doors



rovere naturale (opz.5371)
natural oak (code 5371)



cassetto rovere naturale
(opz.5371)
natural oak drawer
(code 5371)



cestone rovere naturale
(opz.5371)
natural oak deep drawer
(code 5371)

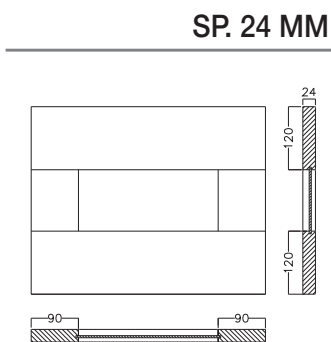

maniglia in legno finitura
rovere naturale (opz.L5371)
wooden handle finished
natural oak (code L5371)
Note: see surcharge page 49

di serie: ante con vetro satinato bianco standard: doors with white frosted glass



rovere naturale (opz.5371B)
natural oak (code 5371B)



cestone vetro rovere naturale
(opz.5371B)
natural oak glass deep drawer
(code 5371B)

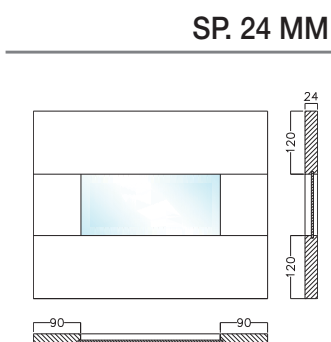

maniglia in legno finitura
rovere naturale (opz.L5371)
wooden handle finished
natural oak (code L5371)
Note: see surcharge page 49

a richiesta: ante con vetro satinato e molato on request: doors with frosted and bevelled glass



rovere naturale (opz.5371M)
natural oak (code 5371M)



cestone vetro rovere naturale
(opz.5371M)
natural oak glass deep drawer
(code 5371M)

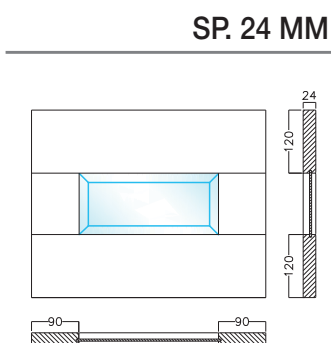

N.B.: CON IL VETRO SATINATO E MOLATO NON SI PUO' INSERIRE LA MANIGLIA "L" IN LEGNO

Note: the "L"-type wooden handle cannot be inserted with the frosted and bevelled glass

cod. **390** impiallacciata a telaio
veneered frame

gallery

SP. 24 MM

ante doors



rovere visone decapè
(opz.5372)
pickled mink oak
(code 5372)



cassetto rovere visone
decapè (opz.5372)
pickled mink oak drawer
(code 5372)



cestone rovere visone decapè
(opz.5372)
pickled mink oak deep drawer
(code 5372)

SP. 24 MM

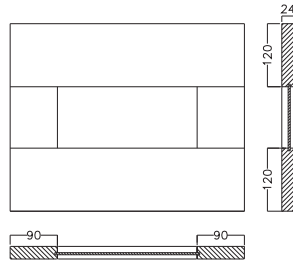

maniglia in legno finitura
rovere visone decapè (opz.L5372)
wooden handle finished
pickled mink oak (code L5372)
Note: see surcharge page 49

di serie: ante con vetro satinato bianco standard: doors with white frosted glass



rovere visone decapè
(opz.5372B)
pickled mink oak
(code 5372B)



cestone vetro rovere visone
decapè (opz.5372B)
pickled mink oak glass
deep drawer (code 5372B)

SP. 24 MM

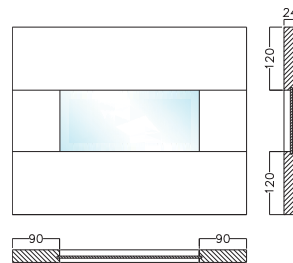

maniglia in legno finitura
rovere visone decapè (opz.L5372)
wooden handle finished
pickled mink oak (code L5372)
Note: see surcharge page 49

a richiesta: ante con vetro satinato e molato on request: doors with frosted and bevelled glass



rovere visone decapè
(opz.5372M)
pickled mink oak
(code 5372M)



cestone vetro rovere visone
decapè (opz.5372M)
pickled mink oak glass
deep drawer (code 5372M)

SP. 24 MM

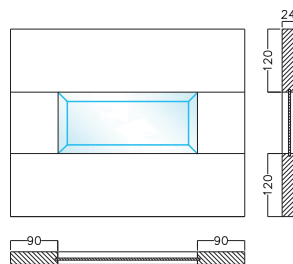

N.B.: CON IL VETRO SATINATO E MOLATO NON
SI PUO' INSERIRE LA MANIGLIA "L" IN LEGNO

Note: the "L"-type wooden handle cannot be
inserted with the frosted and bevelled glass

cod. **390** impiallacciata a telaio
veneered frame

gallery

SP. 24 MM

ante doors



rovere tabacco decapè
(opz.5373)
pickled tobacco oak
(code 5373)



cassetto rovere tabacco
decapè (opz.5373)
pickled tobacco oak drawer
(code 5373)



cestone rovere tabacco decapè
(opz.5373)
pickled tobacco oak deep drawer
(code 5373)

SP. 24 MM

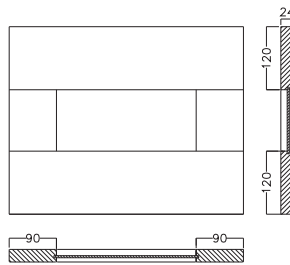

maniglia in legno finitura
rovere tabacco decapè (opz.L5373)
wooden handle finished
pickled tobacco oak (code L5373)
Note: see surcharge page 49

di serie: ante con vetro satinato bianco standard: doors with white frosted glass



rovere tabacco decapè
(opz.5373B)
pickled tobacco oak
(code 5373B)



cestone vetro rovere tabacco
decapè (opz.5373B)
pickled tobacco oak glass deep
drawer (code 5373B)

SP. 24 MM

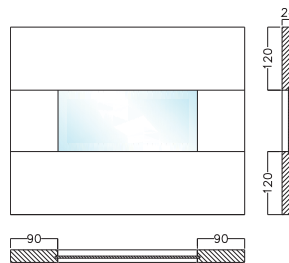

maniglia in legno finitura
rovere tabacco decapè (opz.L5373)
wooden handle finished
pickled tobacco oak (code L5373)
Note: see surcharge page 49

a richiesta: ante con vetro satinato e molato on request: doors with frosted and bevelled glass



rovere tabacco decapè
(opz.5373M)
pickled tobacco oak
(code 5373M)



cestone vetro rovere tabacco
decapè (opz.5373M)
pickled tobacco oak glass deep
drawer (code 5373M)

SP. 24 MM

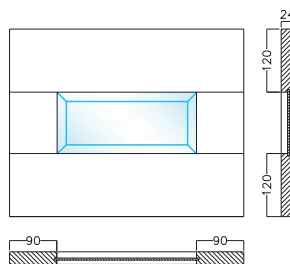

N.B.: CON IL VETRO SATINATO E MOLATO NON
SI PUO' INSERIRE LA MANIGLIA "L" IN LEGNO

Note: the "L"-type wooden handle cannot be
inserted with the frosted and bevelled glass

SP. 24 MM

ante doors



frassino piombo (opz.2465)
lead ash (code 2465)



cassetto frassino piombo (opz.2465)
lead ash drawer (code 2465)



cestone frassino piombo (opz.2465)
lead ash deep drawer (code 2465)

SP. 24 MM

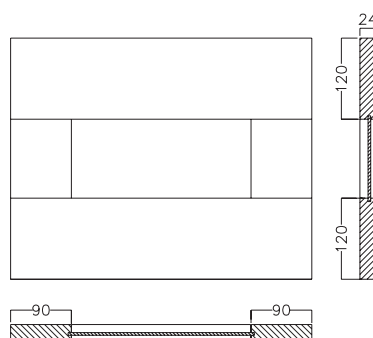

maniglia in legno finitura frassino piombo (opz.L2465)
wooden handle finished

lead ash (code L2465)

di serie: ante con vetro satinato bianco standard: doors with white frosted glass



frassino piombo (opz.2465B)
lead ash (code 2465B)



cestone vetro frassino piombo (opz.2465B)
lead ash glass deep drawer (code 2465B)

SP. 24 MM

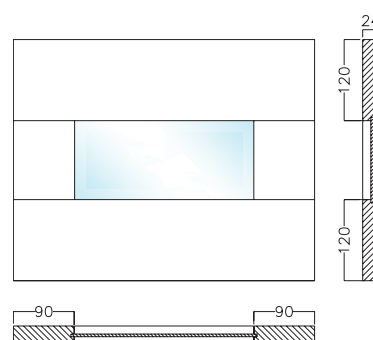

maniglia in legno finitura frassino piombo (opz.L2465)
wooden handle finished

lead ash (code L2465)

a richiesta: ante con vetro satinato e molato on request: doors with frosted and bevelled glass



frassino piombo (opz.2465M)
lead ash (code 2465M)



cestone vetro frassino piombo (opz.2465M)
lead ash glass deep drawer (code 2465M)

SP. 24 MM

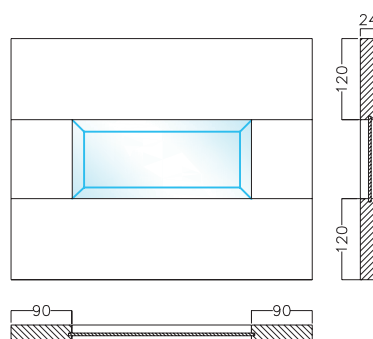

N.B.: CON IL VETRO SATINATO E MOLATO NON SI PUO' INSERIRE LA MANIGLIA "L" IN LEGNO

Note: the "L"-type wooden handle cannot be inserted with the frosted and bevelled glass

cod. **391** telaio laccato opaco soft

SP. 24 MM

gallery

CARATTERISTICHE TECNICHE

ANTE telaio in mdf sp.24 mm laccato finitura opaca soft nei colori:

ANTE VETRO telaio in mdf sp. 24 mm laccato finitura opaco soft nei colori:

MANIGLIE **di serie: 560 finitura cromo passo mm 64/160/320 in funzione dell'anta**

a richiesta:

566 finitura cromo lucido con inserto satinato passo mm 160

561S finitura cromo profili esterni, interno satinato passo mm 64/160/320 in funzione dell'anta

563T finitura cromo, interno tortora passo mm 64/160/320 in funzione dell'anta

477 finitura cromo passo mm 64/160/320 in funzione dell'anta

475C finitura cromo passo mm 96/160/320 in funzione dell'anta

475M finitura brown opaco passo mm 96/160/320 in funzione dell'anta

479C finitura cromo passo mm 96/160/320 in funzione dell'anta

479B finitura bianco opaco passo mm 96/160/320 in funzione dell'anta

565 finitura nikel satinato passo mm 160

490 finitura argento semilucido passo mm 64/160/320 in funzione dell'anta

421 finitura argento passo mm 16

218 finitura nichel antico passo mm 128

per anta L 15 pomo finitura nichel antico 218P

270D finitura dorata con swarovski passo mm 32/128 in funzione dell'anta

L maniglia in legno laccata



CARATTERISTICHE TECNICHE

STRUTTURE

ANTE: bianco assoluto, cenere, verde provenza, titanio, rosa quarzo, lavanda, blu laguna

di serie : nobilitato bianco (opz.001) schiena e ripiano bianco (opz.001)

ANTE: visone, tortora

di serie : nobilitato perla d'oriente (opz.940) schiena e ripiano avorio (opz.930)

a richiesta : nobilitato devalè finitura grafis (opz.796) schiena e ripiano bianco (opz.001)



MENSOLA

di serie: altezza cm 3,8 in laminato perla d'oriente (opz.940), bianco (opz.001), devalè grafis (opz.796)

a richiesta: altezza cm 3,8 laccata opaco soft nei colori come anta

ZOCCOLI

di serie: H 15 in pvc ricoperto in melamina colore alluminio satinato (opz.405)

a richiesta: H 15 in pvc ricoperto in melamina, finitura acciaio spazzolato (opz.407),

H 15 in alluminio finitura brill (opz.412), bianco semilucido (opz.A001), beige semilucido (opz.A444), brown semilucido (opz.A370) vedi magg. accessori pag.201

H 15 in pvc laccati nei colori opachi: bianco assoluto (opz.L740S), cenere (opz.L9547), visone (opz.L946S), tortora (opz.L8991), verde provenza (opz.L8465), titanio (opz.L9545), rosa quarzo (opz.L8181), lavanda (opz.L9141), blu laguna (opz.L8365), vedi magg. accessori pag 201



cod. **391** soft matt lacquered frame

TH. 24 MM

gallery

TECHNICAL FEATURES

DOORS mdf frame, th. 24 mm, with soft matt lacquer finish in the following colours:

GLASS DOORS mdf frame, th. 24 mm, with soft matt lacquer finish in the following colours:

 [CLICCA QUI PER LA GAMMA COLORI DISPONIBILI](#)

 [CLICK HERE FOR THE RANGE OF AVAILABLE COLORS](#)

HANDLES **standard:** 560 chrome finish, 64/160/320 centre-to-centre distance according to door size

on request:

566 polished chrome finish with satin insert, 160 mm centre-to-centre distance
561S external profile chrome finish, satin interior, 64/160/320 centre-to-centre distance according to door size
561T external profile chrome finish, dove grey interior, 64/160/320 centre-to-centre distance according to door size
563T chrome finish, dove grey interior, 64/160/320 centre-to-centre distance according to door size

477 chrome finish, 64/160/320 centre-to-centre distance according to door size

475C chrome finish, 96/160/320 mm centre-to-centre distance according to door size
475M matt brown finish, 96/160/320 mm centre-to-centre distance according to door size
479C chrome finish, 96/160/320 mm centre-to-centre distance according to door size
479B matt white finish, 96/160/320 mm centre-to-centre distance according to door size

565 satin nickel finish, 160 mm centre-to-centre distance

490 semi-polished silver finish, 64/160/320 centre-to-centre distance according to door size
421 silver finish, 16 mm centre-to-centre distance
218 antique nickel finish 128 mm centre-to-centre distance for door W 15 antique nickel finish knob hole 218P
270D gold finish with swarovski crystals, centre-to-centre distance mm 32/128 according to door size
L-type lacquered wooden handle



TECHNICAL FEATURES

STRUCTURES

DOORS: absolute white, ash, provence green, titanium, quartz pink, lavender, lagoon blue

standard: melamine-coated white (code 001), white back panel and shelf (code 001)

DOORS: mink, dove grey

standard: melamine-coated oriental pearl (code 940), ivory back panel and shelf (code 930)

on request: melamine-coated devalè with grafis finish (code 796), white back panel and shelf (code 001)

SHELF

standard: height 3.8 cm, in oriental pearl laminate (code 940), white (code 001), devalè with grafis finish (code 796)

on request: height 3.8 cm, soft matt lacquer finish in the same colours as the doors

PLINTHS

standard: height 15 cm, melamine faced PVC with frosted aluminium finish (code 405)

on request: height 15 cm, melamine faced PVC with brushed steel finish (code 407)

height 15 in brill-finish aluminium (code 412), semi-polished white (code A001), semi-polished beige (code A444), semi-polished brown (code A370) see accessories surcharges page 201

height 15 cm, matt lacquered pvc in the following colours: absolute white (code L740S), ash (code L9547), mink (code L9465), dove grey (code L8991), provence green (code L8465), titanium (code L9545), quartz pink (code L8181), lavender (code L9141), lagoon blue (code L8365), see accessories surcharges pag. 201

[CLICCA QUI PER LA GAMMA COLORI DISPONIBILI](#)

[CLICK HERE FOR THE RANGE OF AVAILABLE COLORS](#)

cod. **391** telaio laccato opaco soft
soft matt lacquered frame

gallery

SP. 24 MM TH. 24 MM

ante doors



SP. 24 MM

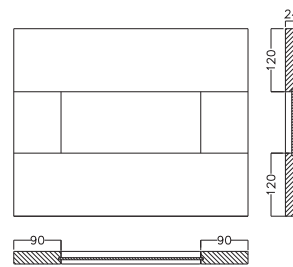

anta con maniglia "L"
in legno laccata come ante
door with wooden handle "L-type"
lacquered same colour as door

Note: see surcharge page 49

di serie: ante con vetro satinato bianco standard: doors with white frosted glass



SP. 24 MM

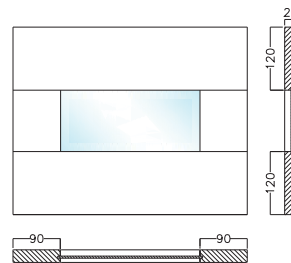

anta con maniglia "L"
in legno laccata come ante
door with wooden handle "L-type"
lacquered same colour as door

Note: see surcharge page 49

a richiesta: ante con vetro satinato e molato on request: doors with frosted and bevelled glass



SP. 24 MM

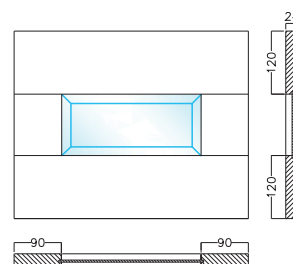

N.B.: CON IL VETRO SATINATO E MOLATO NON SI PUO' INSERIRE LA MANIGLIA "L" IN LEGNO

Note: the "L"-type wooden handle cannot be inserted with the frosted and bevelled glass

cod. **392** liscia laccata opaca soft

SP. 24 MM

gallery

CARATTERISTICHE TECNICHE

ANTE E FRONTALI CASSETTI

anta in mdf sp.24 mm laccata finitura opaca testurizzata soft nei colori:

[CLICCA QUI PER LA GAMMA COLORI DISPONIBILI](#)

[CLICK HERE FOR THE RANGE OF AVAILABLE COLORS](#)

ANTE VETRO

telaio in mdf sp.24 mm laccata finitura opaca testurizzata soft nei colori:

[CLICCA QUI PER LA GAMMA COLORI DISPONIBILI](#)

[CLICK HERE FOR THE RANGE OF AVAILABLE COLORS](#)

MANIGLIE

di serie: 560 finitura cromo passo mm 64/160/320 in funzione dell'anta

a richiesta:

566 finitura cromo lucido con inserto satinato passo mm 160

561S finitura cromo profili esterni, interno satinato passo mm 64/160/320 in funzione dell'anta

561T finitura cromo profili esterni, interno tortora passo mm 64/160/320 in funzione dell'anta

563T finitura cromo, interno tortora passo mm 64/160/320 in funzione dell'anta

477 finitura cromo passo mm 64/160/320 in funzione dell'anta

475C finitura cromo passo mm 96/160/320 in funzione dell'anta

475M finitura brown opaco passo mm 96/160/320 in funzione dell'anta

479C finitura cromo passo mm 96/160/320 in funzione dell'anta

479B finitura bianco opaco passo mm 96/160/320 in funzione dell'anta

565 finitura nikel satinato passo mm 160

490 finitura argento semilucido passo mm 64/160/320 in funzione dell'anta

421 finitura argento passo mm 16

218 finitura nichel antico passo mm 128

per anta L 15 pomo finitura nichel antico 218P

270D finitura dorata con swarovski passo mm 32/128 in funzione dell'anta



CARATTERISTICHE TECNICHE

STRUTTURE

di serie: nobilitato bianco (opz.001) schiena e ripiano bianco (opz.001)

a richiesta: nobilitato perla d'oriente (opz.940) schiena e ripiano avorio (opz.930)
nobilitato devalè finitura grafis (opz.796) schiena e ripiano bianco (opz.001)



MENSOLE

di serie: altezza cm 3,8 in laminato bianco (opz.001), perla d'oriente (opz.940), devalè finitura grafis (opz.796)

a richiesta: altezza cm 3,8 laccate come ante

ZOCCOLI

di serie: H 15 in pvc ricoperto in melamina colore alluminio satinato (opz.405)

a richiesta: H 15 in pvc ricoperto in melamina, finitura acciaio spazzolato (opz.407),
H 15 in alluminio finitura brill (opz.412), bianco semilucido (opz.A001),
beige semilucido (opz.A444), brown semilucido (opz.A370) vedi magg. accessori pag.201



cod. **392** smooth soft matt lacquered

TH.24 MM

gallery

TECHNICAL FEATURES

DOORS AND DRAWER FRONTS

mdf door, th. 24 mm, with soft textured matt lacquer finish in the following colours:

[CLICCA QUI PER LA GAMMA COLORI DISPONIBILI](#)

[CLICK HERE FOR THE RANGE OF AVAILABLE COLORS](#)

GLASS DOORS

mdf frame, th. 24 mm, with soft textured matt lacquer finish in the following colours:

[CLICCA QUI PER LA GAMMA COLORI DISPONIBILI](#)

[CLICK HERE FOR THE RANGE OF AVAILABLE COLORS](#)

HANDLES

standard: 560 chrome finish, 64/160/320 centre-to-centre distance according to door size

on request:

566 polished chrome finish with satin insert, 160 mm centre-to-centre distance

561S external profile chrome finish, satin interior, 64/160/320 centre-to-centre distance according to door size

561T external profile chrome finish, dove grey interior, 64/160/320 centre-to-centre distance according to door size

563T chrome finish, dove grey interior, 64/160/320 centre-to-centre distance according to door size

477 chrome finish, 64/160/320 centre-to-centre distance according to door size

475C chrome finish, 96/160/320 mm centre-to-centre distance according to door size

475M matt brown finish, 96/160/320 mm centre-to-centre distance according to door size

479C chrome finish, 96/160/320 mm centre-to-centre distance according to door size

479B matt white finish, 96/160/320 mm centre-to-centre distance according to door size

565 satin nickel finish, 160 mm centre-to-centre distance

490 semi-polished silver finish, 64/160/320 centre-to-centre distance according to door size

421 silver finish, 16 mm centre-to-centre distance

218 antique nickel finish 128 mm centre-to-centre distance for door W 15 antique nickel finish knob hole 218P

270D gold finish with swarovski crystals, centre-to-centre distance mm 32/128 according to door size



TECHNICAL FEATURES

STRUCTURES

standard: melamine-coated white (code 001), white back panel and shelf (code 001)

on request: melamine-coated oriental pearl (code 940), ivory back panel and shelf (code 930)
melamine-coated devalè with grafis finish (code 796), white back panel and shelf (code 001)

SHELVES

standard: height 3.8 cm, in laminate in white (code 001), oriental pearl (code 940), devalè with grafis finish (code 796)

on request: height 3.8 cm, lacquered in same finish as doors

PLINTHS

standard: height 15 cm, melamine faced PVC with frosted aluminium finish (code 405)

on request: height 15 cm, melamine faced PVC with brushed steel finish (code 407)
height 15 in brill-finish aluminium (code 412), semi-polished white (code A001),
semi-polished beige (code A444), semi-polished brown (code A370) see accessories surcharges page 201

cod. **392** liscia laccata opaca soft
smooth soft matt lacquered

SP. 24 MM

gallery

ante doors



SP. 24 MM

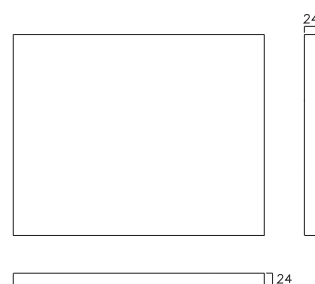

di serie: ante con vetro satinato bianco
standard: doors with white frosted glass

a richiesta: ante con vetro satinato e molato
on request: doors with frosted and bevelled glass



SP. 24 MM

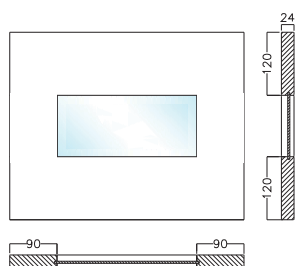

SP. 24 MM

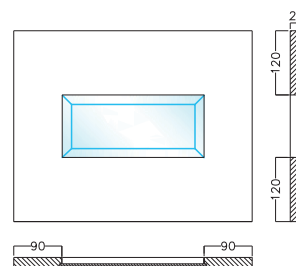

cod. **393** liscia laccata lucida

gallery

SP. 24 MM

CARATTERISTICHE TECNICHE

ANTE E FRONTALI CASSETTI

anta in mdf sp.24 mm laccata finitura lucida nei colori:

[CLICCA QUI PER LA GAMMA COLORI DISPONIBILI](#)

[CLICK HERE FOR THE RANGE OF AVAILABLE COLORS](#)

ANTE VETRO

telaio in mdf sp.24 mm laccata finitura lucida nei colori:

[CLICCA QUI PER LA GAMMA COLORI DISPONIBILI](#)

[CLICK HERE FOR THE RANGE OF AVAILABLE COLORS](#)

MANIGLIE

di serie: 560 finitura cromo passo mm 64/160/320 in funzione dell'anta

a richiesta:

566 finitura cromo lucido con inserto satinato passo mm 160

561S finitura cromo profili esterni, interno satinato passo mm 64/160/320 in funzione dell'anta

561T finitura cromo profili esterni, interno tortora passo mm 64/160/320 in funzione dell'anta

563T finitura cromo, interno tortora passo mm 64/160/320 in funzione dell'anta

477 finitura cromo passo mm 64/160/320 in funzione dell'anta

475C finitura cromo passo mm 96/160/320 in funzione dell'anta

475M finitura brown opaco passo mm 96/160/320 in funzione dell'anta

479C finitura cromo passo mm 96/160/320 in funzione dell'anta

479B finitura bianco opaco passo mm 96/160/320 in funzione dell'anta

565 finitura nikel satinato passo mm 160

490 finitura argento semilucido passo mm 64/160/320 in funzione dell'anta

421 finitura argento passo mm 16

218 finitura nichel antico passo mm 128

per anta L 15 pomo finitura nichel antico 218P

270D finitura dorata con swarovski passo mm 32/128 in funzione dell'anta



CARATTERISTICHE TECNICHE

STRUTTURE

di serie: nobilitato bianco (opz.001) schiena e ripiano bianco (opz.001)

a richiesta: nobilitato perla d'oriente (opz.940) schiena e ripiano avorio (opz.930)
nobilitato devalè finitura grafis (opz.796) schiena e ripiano bianco (opz.001)



MENSOLE

di serie: altezza cm 3,8 in laminato bianco (opz.001), perla d'oriente (opz.940), devalè finitura grafis (opz.796)

a richiesta: altezza cm 3,8 laccate come ante

ZOCCOLI

di serie: H 15 in pvc ricoperto in melamina colore alluminio satinato (opz.405)

a richiesta: H 15 in pvc ricoperto in melamina, finitura acciaio spazzolato (opz.407),
H 15 in alluminio finitura brill (opz.412), bianco semilucido (opz.A001),
beige semilucido (opz.A444), brown semilucido (opz.A370) vedi magg. accessori pag.201



cod. **393** smooth glossy lacquered

TH.24 MM

gallery

TECHNICAL FEATURES

DOORS AND DRAWER FRONTS

mdf door, th. 24 mm, with glossy lacquer finish in the following colours:

[CLICCA QUI PER LA GAMMA COLORI DISPONIBILI](#)

[CLICK HERE FOR THE RANGE OF AVAILABLE COLORS](#)

GLASS DOORS

mdf frame, th. 24 mm, with glossy lacquer finish in the following colours:

[CLICCA QUI PER LA GAMMA COLORI DISPONIBILI](#)

[CLICK HERE FOR THE RANGE OF AVAILABLE COLORS](#)

HANDLES

standard: 560 chrome finish, 64/160/320 centre-to-centre distance according to door size

on request:

566 polished chrome finish with satin insert, 160 mm centre-to-centre distance

561S external profile chrome finish, satin interior, 64/160/320 centre-to-centre distance according to door size

561T external profile chrome finish, dove grey interior, 64/160/320 centre-to-centre distance according to door size

563T chrome finish, dove grey interior, 64/160/320 centre-to-centre distance according to door size

477 chrome finish, 64/160/320 centre-to-centre distance according to door size

475C chrome finish, 96/160/320 mm centre-to-centre distance according to door size

475M matt brown finish, 96/160/320 mm centre-to-centre distance according to door size

479C chrome finish, 96/160/320 mm centre-to-centre distance according to door size

479B matt white finish, 96/160/320 mm centre-to-centre distance according to door size

565 satin nickel finish, 160 mm centre-to-centre distance

490 semi-polished silver finish, 64/160/320 centre-to-centre distance according to door size

421 silver finish, 16 mm centre-to-centre distance

218 antique nickel finish 128 mm centre-to-centre distance

for door W 15 antique nickel finish knob hole 218P

270D gold finish with swarovski crystals, centre-to-centre distance mm 32/128 according to door size



TECHNICAL FEATURES

STRUCTURES

standard: melamine-coated white (code 001), white back panel and shelf (code 001)

on request: melamine-coated oriental pearl (code 940), ivory back panel and shelf (code 930)
melamine-coated devalè with grafis finish (code 796), white back panel and shelf (code 001)

SHELVES

standard: height 3.8 cm, in laminate in white (code 001), oriental pearl (code 940), devalè with grafis finish (code 796)

on request: height 3.8 cm, lacquered in same finish as doors

PLINTHS

standard: height 15 cm, melamine faced PVC with frosted aluminium finish (code 405)

on request: height 15 cm, melamine faced PVC with brushed steel finish (code 407)
height 15 in brill-finish aluminium (code 412), semi-polished white (code A001),
semi-polished beige (code A444), semi-polished brown (code A370) see accessories surcharges page 201

cod. **393** liscia laccata lucida
smooth glossy lacquered

SP. 24 MM

gallery

ante doors



SP. 24 MM

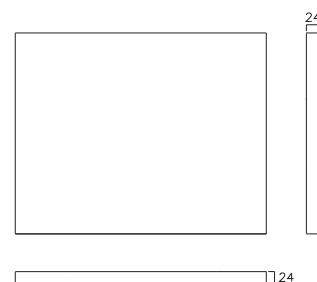

di serie: ante con vetro satinato bianco
standard: doors with white frosted glass

a richiesta: ante con vetro satinato e molato
on request: doors with frosted and bevelled glass



SP. 24 MM

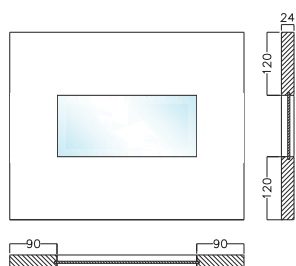

SP. 24 MM

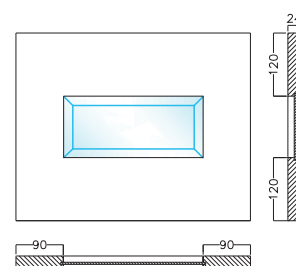

gallery

strutture carcasses



bianco (opz.001)
schiena e ripiano bianco (opz.001)
white (code 001)
white back panel and shelf (code 001)



perla d'oriente (opz.940)
schiena e ripiano avorio (opz.930)
oriental pearl (code 940)
ivory back panel and shelf (code 930)



devalè finitura grafis (opz.796)
schiena e ripiano bianco (opz.001)
devalè with grafis finish (code 796)
white back panel and shelf (code 001)



noce guarnieri (opz.050)
schiena e ripiano avorio (opz.930)
guarnieri walnut (code 050)
ivory back panel and shelf (code 930)



rovere sbiancato (opz.025)
schiena e ripiano avorio (opz.930)
bleached oak (code 025)
ivory back panel and shelf (code 930)



LUBE ECOLOGIC

IL GRUPPO LUBE HA SCELTO DI UTILIZZARE PER I COMPONENTI COSTITUENTI LE STRUTTURE DELLE CUCINE SOLO MATERIALE A BASSISSIMA EMISSIONE DI FORMALDEIDE: CONFORMI ALLO STANDARD F**** SECONDO LA NORMA JIS, CERTIFICATO DAL MINISTERO GIAPPONESE. IL PIÙ SEVERO IN MERITO ALLE NORMATIVE DI SALVAGUARDIA AMBIENTALE.

LUBE GROUP HAS CHOSEN TO EXCLUSIVELY USE MATERIALS WITH VERY LOW FORMALDEHYDE EMISSIONS FOR THE COMPONENTS MAKING UP THE KITCHEN CARCASSES: THESE ELEMENTS COMPLY WITH THE F4 STAR STANDARD ACCORDING TO JIS, CERTIFIED BY THE JAPANESE GOVERNMENT - THE MOST STRINGENT WHEN IT COMES TO ENVIRONMENTAL PROTECTION.

mensole in laminato laminate shelves



bianco (opz.001)
white (code 001)



perla d'oriente (opz.940)
oriental pearl (code 940)



noce guarnieri (opz.050)
quarnieri walnut (code 050)



rovere sbiancato (opz.025)
bleached oak (code 025)



devalè finitura grafis (opz.796)
devalè with grafis finish (code 796)

mensole impiallacciate veneered shelves



impiallacciata come anta
N.B.: per le finiture vedi colori ante legno
veneered same finish as door
Note: for the finishes see wooden door colours

mensole laccate lacquered shelves



laccate opache e lucide come anta
N.B.: per le finiture vedi colori ante laccate
matt and glossy lacquered as door
Note: for the finishes see lacquered door colours

zoccoli in pvc H 15 PVC plinth H 15



alluminio satinato
(opz.405)
satin aluminium



acciaio spazzolato
(opz.407)
brushed steel

zoccoli in alluminio H 15

aluminium plinths H 15



alluminio liscio
finitura brill (opz.412)
smooth aluminium
with brill finish



alluminio bianco
semilucido (opz.A001)
semi-polished white
aluminium



alluminio beige
semilucido (opz.A444)
semi-polished beige
aluminium



alluminio brown
semilucido (opz.A370)
semi-polished brown
aluminium

zoccoli in pvc laccati opachi H 15

pvc plinths lacquered matt H 15

top H 4 consigliati in laminato bordo postformato

recommended laminate worktops H 4 with post-formed edge

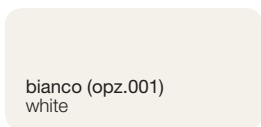

bianco (opz.001)
white

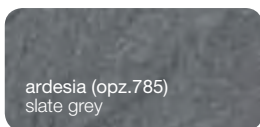

ardesia (opz.785)
slate grey

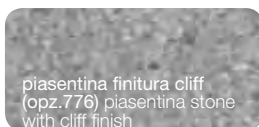

piassetina finitura cliff
(opz.776) piassetina stone
with cliff finish

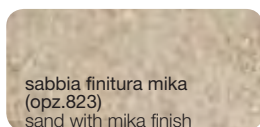

sabbia finitura mika
(opz.823)
sand with mika finish

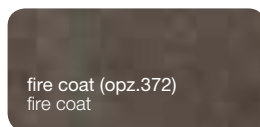

fire coat (opz.372)
fire coat



glitter bianco lucido
(opz.790)
polished white glitter stone

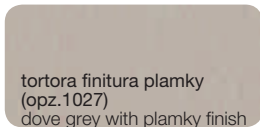

tortora finitura plamky
(opz.1027)
dove grey with plamky finish

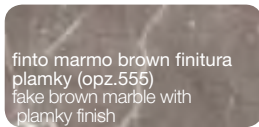

finto marmo brown finitura
plamky (opz.555)
fake brown marble with
plamky finish

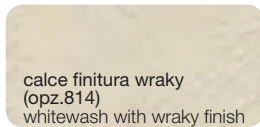

calce finitura wraky
(opz.814)
whitewash with wraky finish



grigio cemento finitura
touch (opz.786)
grey cement with touch finish

top H 4 consigliati in laminato bordo ABS 1

recommended laminate worktops H 4 with ABS 1 edge



bianco finitura velvet
(opz.800)
white with velvet finish

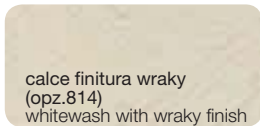

calce finitura wraky
(opz.814)
whitewash with wraky finish

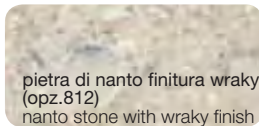

pietra di nanto finitura wraky
(opz.812)
nanto stone with wraky finish

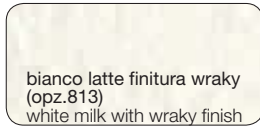

bianco latte finitura wraky
(opz.813)
white milk with wraky finish

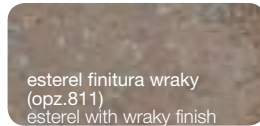

esterel finitura wraky
(opz.811)
esterel with wraky finish



caffè finitura cristal
(opz.831)
coffee with crystal finish

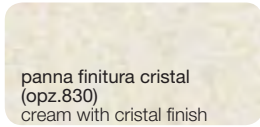

panna finitura cristal
(opz.830)
cream with cristal finish



sabbia vintage finitura plamky
(opz.783)
vintage sand with plamky finish



antracite finitura flatting
(opz.858)
anthracite with flatting finish

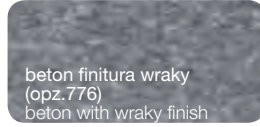

beton finitura wraky
(opz.776)
beton with wraky finish

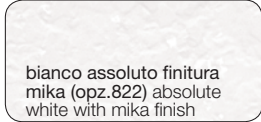

bianco assoluto finitura
mika (opz.822) absolute
white with mika finish



bianco neve finitura
flatting (opz.850)
snow with flatting finish

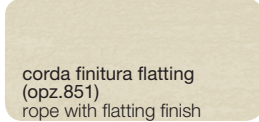

corda finitura flatting
(opz.851)
rope with flatting finish

MANIGLIE HANDLES

gallery

DI SERIE STANDARD



Maniglia 560 finitura cromo
anta L 15 → passo 64 mm
anta da L 30 a L 45 → passo 160 mm
anta da L 60 a L 120 → passo 320 mm

Handle 560 chrome finish
door W 15 → centre-to-centre distance 64 mm
door from W 30 to W 45 → centre-to-centre distance 160 mm
door from W 60 to W 120 → centre-to-centre distance 320 mm



Maniglia 565 finitura nichel satinato
passo 160 mm

Handle 565 nichel satin finish
centre-to-centre distance 160 mm



Maniglia 477 finitura cromo
anta L 15 → passo 64 mm
anta da L 30 a L 45 → passo 160 mm
anta da L 60 a L 120 → passo 320 mm

Handle 477 chrome finish
door W 15 → centre-to-centre distance 64 mm
door from W 30 to W 45 → centre-to-centre distance 160 mm
door from W 60 to W 120 → centre-to-centre distance 320 mm



Maniglia 490 finitura argento semilucido
anta L 15 → passo 64 mm
anta da L 30 a L 45 → passo 160 mm
anta da L 60 a L 120 → passo 320 mm

Handle 490 semi-polished silver finish
door W 15 → centre-to-centre distance 64 mm
door from W 30 to W 45 → centre-to-centre distance 160 mm
door from W 60 to W 120 → centre-to-centre distance 320 mm



Maniglia 475C finitura cromo
anta L 15 → passo 96 mm
anta da L 30 a L 45 → passo 160 mm
anta da L 60 a L 120 → passo 320 mm

Handle 475C chrome finish
door W 15 → centre-to-centre distance 96 mm
door from W 30 to W 45 → centre-to-centre distance 160 mm
door from W 60 to W 120 → centre-to-centre distance 320 mm



Maniglia 475M finitura brown opaco
anta L 15 → passo 96 mm
anta da L 30 a L 45 → passo 160 mm
anta da L 60 a L 120 → passo 320 mm

Handle 475M matt brown finish
door W 15 → centre-to-centre distance 96 mm
door from W 30 to W 45 → centre-to-centre distance 160 mm
door from W 60 to W 120 → centre-to-centre distance 320 mm



Pomo 421 finitura argento
passo 16 mm

Knob 421 silver finish
centre-to-centre distance 16 mm



Maniglia 479C finitura cromo
anta L 15 → passo 96 mm
anta da L 30 a L 45 → passo 160 mm
anta da L 60 a L 120 → passo 320 mm

Handle 479C chrome finish
door W 15 → centre-to-centre distance 96 mm
door from W 30 to W 45 → centre-to-centre distance 160 mm
door from W 60 to W 120 → centre-to-centre distance 320 mm



Maniglia 479B finitura bianco opaco
anta L 15 → passo 96 mm
anta da L 30 a L 45 → passo 160 mm
anta da L 60 a L 120 → passo 320 mm

Handle 479B matt white finish
door W 15 → centre-to-centre distance 96 mm
door from W 30 to W 45 → centre-to-centre distance 160 mm
door from W 60 to W 120 → centre-to-centre distance 320 mm



Maniglia 218 finitura nichel antico
passo 128 mm

Handle 218 nichel antique finish
centre-to-centre distance 128 mm



Pomo 218P finitura nichel antico
utilizzato per elementi da 15
con maniglia 218

Knob 218P nichel antique finish
used for W15 elements with
handle 218



Maniglia 561S finitura satinata
anta L 15 → passo 64 mm
anta da L 30 a L 45 → passo 160 mm
anta da L 60 a L 120 → passo 320 mm

Handle 561S satin finish
door W 15 → centre-to-centre distance 64 mm
door from W 30 to W 45 → centre-to-centre distance 160 mm
door from W 60 to W 120 → centre-to-centre distance 320 mm



**Maniglia 566 finitura cromo lucido
con inserto satinato**
passo 160 mm

Handle 566 polished chrome finish
with satin insert
centre-to-centre distance 160 mm



Maniglia 561T finitura tortora
anta L 15 → passo 64 mm
anta da L 30 a L 45 → passo 160 mm
anta da L 60 a L 120 → passo 320 mm

Handle 561T dove grey finish
door W 15 → centre-to-centre distance 64 mm
door from W 30 to W 45 → centre-to-centre distance 160 mm
door from W 60 to W 120 → centre-to-centre distance 320 mm

MANIGLIE HANDLES

gallery



Maniglia 563T finitura cromo interno tortora
anta L 15 → passo 64 mm
anta da L 30 a L 45 → passo 160 mm
anta da L 60 a L 120 → passo 320 mm

Handle 563T chrome finish dove grey interior
door W 15 → centre-to-centre distance 64 mm
door from W 30 to W 45 → centre-to-centre distance 160 mm
door from W 60 to W 120 → centre-to-centre distance 320 mm



Maniglia 270D finitura dorata con swarovski
anta L 15 → passo 32 mm
anta da L 30 a L 120 → passo 128 mm

Handle 270D golden finish with swarovski
door W 15 → centre-to-centre distance 32 mm
door from W 30 to W 120 → centre-to-centre distance 128 mm

MANIGLIA "L" IN LEGNO WOODEN "L"-TYPE HANDLE

gallery



Maniglia "L" finitura come anta telaio laccata
"L"-type handle same finish as lacquer framed door



Maniglia "L" finitura come anta legno
(non disponibile nelle finiture noce nazionale,
frassino bianco decapè argento e frassino fango decapè argento)
Handle "L"-type same finish as wooden door
(not available for walnut, pickled silver white ash and pickled silver mud grey ash finishes)

gallery

SCHEMA MANIGLIA "L" IN LEGNO WOODEN HANDLE "L"-TYPE DIAGRAM

MANIGLIE PER PENSILI WALL UNITS HANDLES

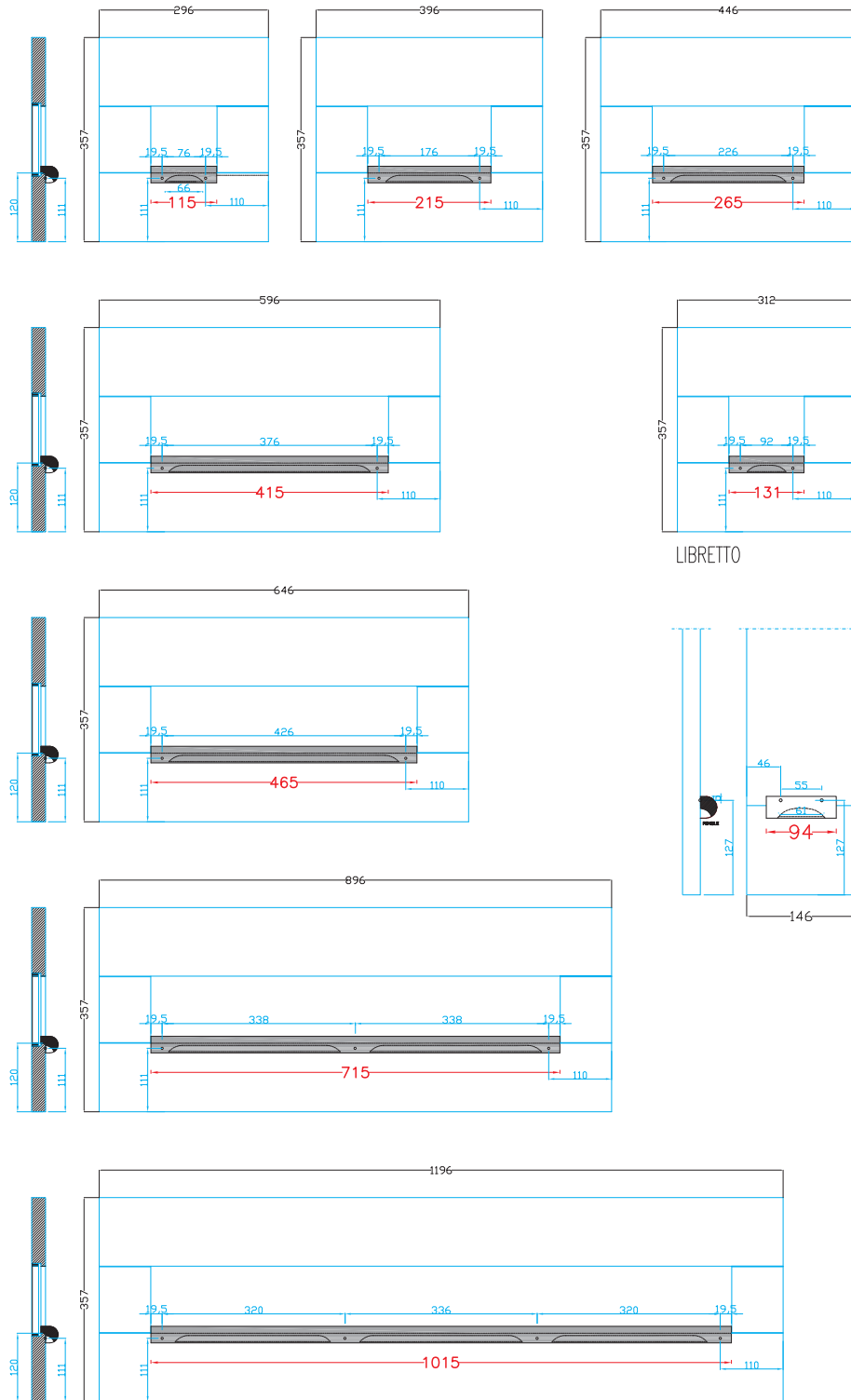

gallery

SCHEMA MANIGLIA "L" IN LEGNO WOODEN HANDLE "L"-TYPE DIAGRAM

MANIGLIE PER BASI BASE UNITS HANDLES

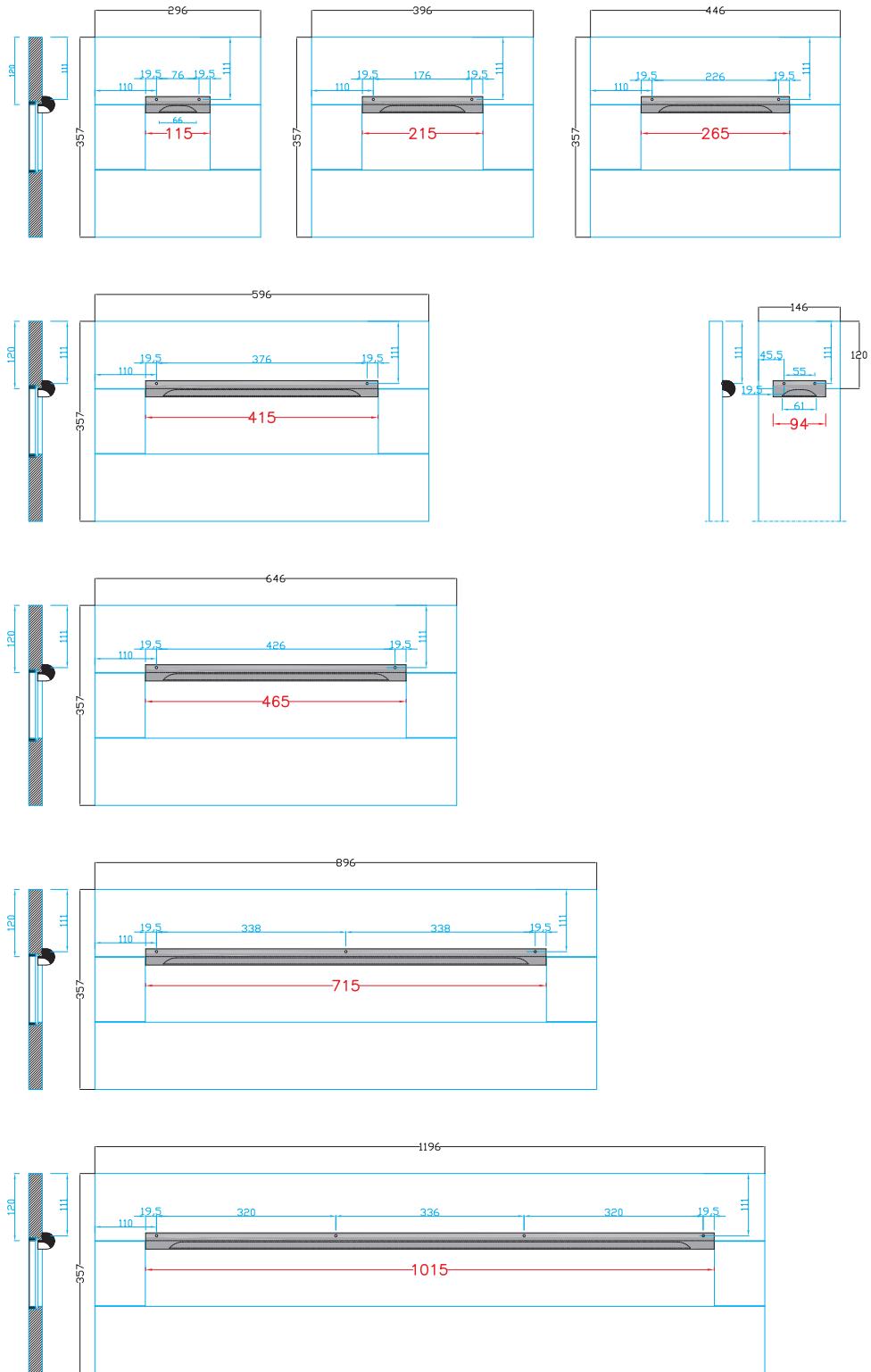

SCHEMA MANIGLIA "L" IN LEGNO WOODEN HANDLE "L"-TYPE DIAGRAM

MANIGLIE PER CASSETTI DRAWERS HANDLES

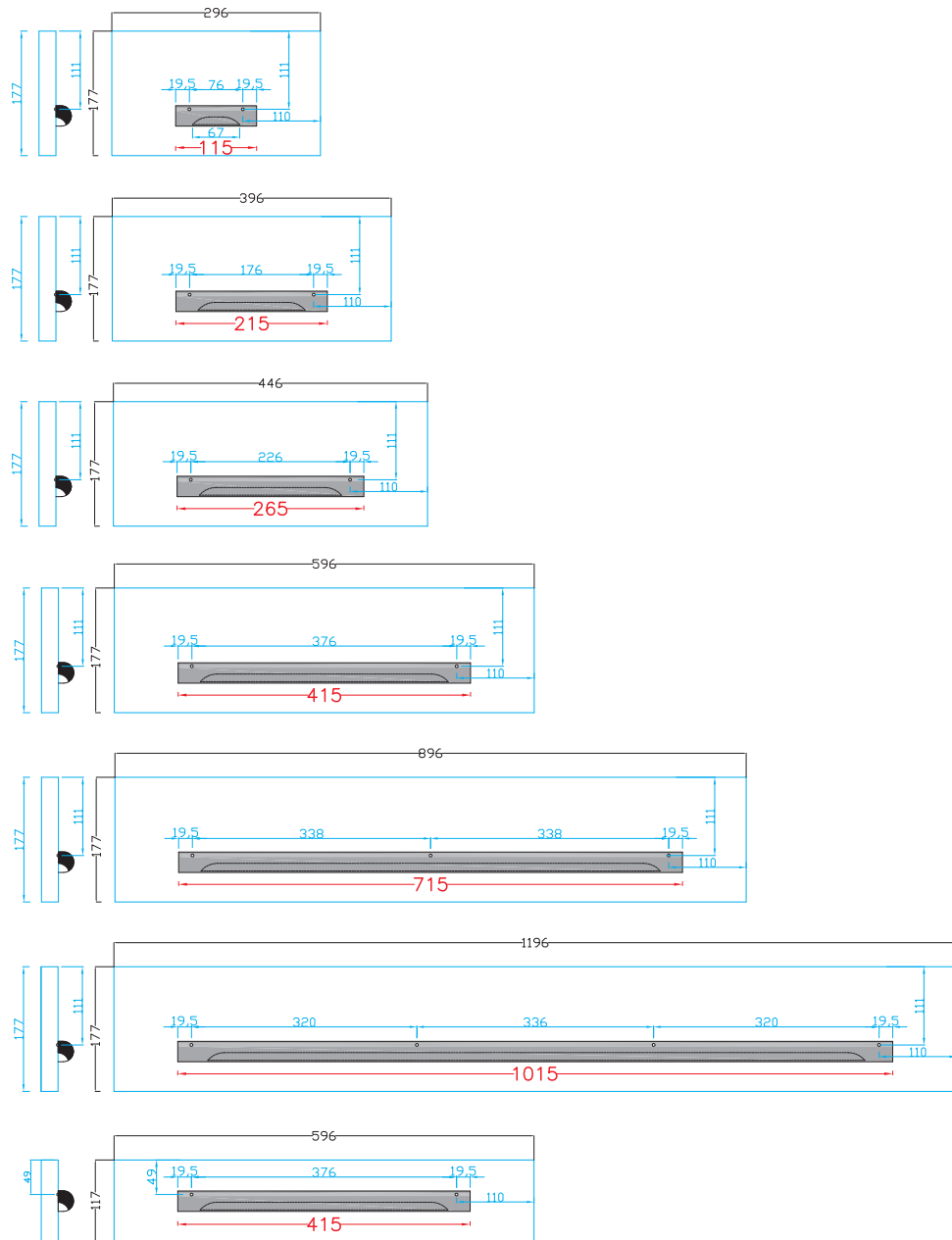



MECCANISMI MOTORIZZATI SERVO-DRIVE

SERVO-DRIVE MOTORISED
MECHANISMS

gallery

Estrema facilità di apertura e chiusura ante

Extreme ease in opening and closing the doors

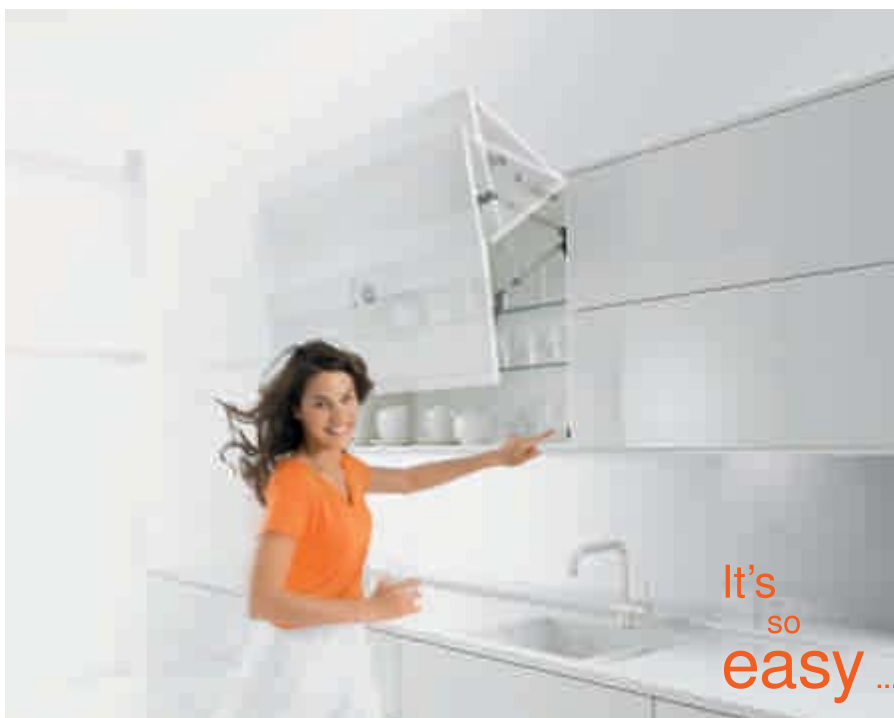

N.B.: il SERVO-DRIVE non può essere installato successivamente ma deve essere richiesto contemporaneamente all'ordine del pensile.

Motorizzato SERVO-DRIVE (Opz.007)

Maggiorazione + € 380,00

NOTE: SERVO-DRIVE cannot be installed at a later date but must be ordered at the same time with the wall unit.

SERVO-DRIVE motorised (Opt.007)

Surcharge + € 380,00

APERTURA ANTE A PACCHETTO

LIFT-UP FOLDING DOOR OPENING



APERTURA VERTICALE OBLIQUA

OBLIQUE VERTICAL OPENING



APERTURA RIBALTA

FLAPDOOR OPENING



APERTURA VERTICALE

VERTICAL OPENING



ESTREMAMENTE FACILE DA UTILIZZARE
EXTREMELY EASY TO USE

gallery



Grazie a **SERVO-DRIVE** basta una leggera pressione sul fronte con la mano o il gomito per aprire automaticamente le ante a ribalta.

Persino i frontali grandi e pesanti si aprono verso l'alto come in totale assenza di gravità. Inoltre, l'utilizzatore della cucina può godere di un accesso ottimale all'interno del mobile.

Thanks to **SERVO-DRIVE**, just apply light pressure to the front panel with the hand or elbow to automatically open the folding doors.

Even large front panels open upwards with a complete lack of gravity. In addition, the opening provides optimum access to the cabinet interior.



Chiusura comoda e semplice, assicurata dall'interruttore facilmente raggiungibile, montato sul fianco del corpo mobile.

Le chiusure delle ante a ribalta risulta così estremamente comoda ed ergonomica, mentre la rinomata funzione **BLUMOTION** garantisce una chiusura dolce e silenziosa.

Simple and comfortable closure by using an easy-to-reach switch fitted on the side of the cabinet.

Closing the folding doors is so easy, comfortable and ergonomic. The renowned **BLUMOTION** function also ensures gentle and silent closing.



KIT TRASFORMATORE

POWER SUPPLY KIT

gallery

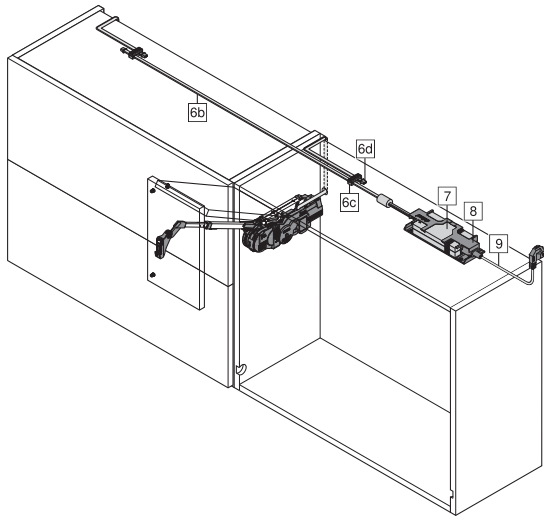

Kit trasformatore composto da:
Power supply kit includes:

- 6b** Cavo di distribuzione lunghezza 8 mt
Power supply cable length 8 m
 - 6c** 1 Connettore
Connector
 - 6d** Protezione estremità cavo
Cable end protection
 - 7** Trasformatore universale per tutti paesi del mondo
72 W completo di supporto per il montaggio
Universal power supply worldwide,
72 W complete with mounting bracket
 - 8** Supporto trasformatore
Power supply mounting bracket
 - 9** Cavo di alimentazione elettrica UE
EU electrical power supply cable
- i** Per ogni cavo di distribuzione può essere collegato un solo trasformatore Blum.
Only one Blum power supply may be connected to each power supply cable.

Per il meccanismo elettrico motorizzato SERVO-DRIVE richiedere sempre il kit trasformatore, codice 5615850 - Un trasformatore può alimentare fino a 10 motori.

N.B.: si potrebbero verificare situazioni dove occorre utilizzare più di un kit trasformatore.

For the motorised electric SERVO-DRIVE mechanism, always request the power supply kit: code 5615850 -

One power supply can power up to 10 motors.

NOTE: in some cases one may use more than one power supply kit.

PENSILI SU PARETI CONTINUE

CONTINUOUS WALL UNITS

COMPOSIZIONE "A"

COMPOSITION "A"

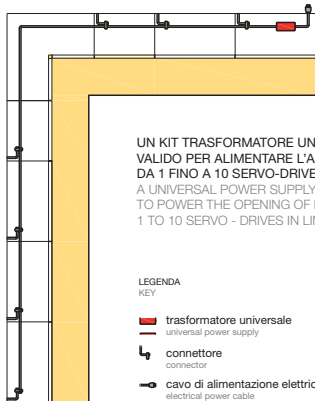

PENSILI SU PARETI SEPARATE

SEPARATE WALL UNITS

COMPOSIZIONE "B"

COMPOSITION "B"

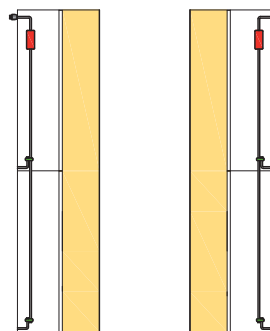

PER OGNI SINGOLA PARETE OCCORRE UN KIT TRASFORMATORE UNIVERSALE PER ALIMENTARE L'APERTURA DA 1 FINO A 10 SERVO - DRIVE IN LINEA
A UNIVERSAL POWER SUPPLY KIT FOR EACH WALL TO POWER THE OPENING OF FROM 1 TO 10 SERVO - DRIVES IN LINE

LEGENDA
KEY

- trasformatore universale
universal power supply
- connettore
connector
- cavo di alimentazione elettrica
electrical power cable

PENSILI APERTURA VERTICALE OBLIQUA CHIUSURA BLUMOTION

P 33,6

WALL UNITS VERTICAL OBLIQUE OPENING AND BLUMOTION CLOSING SYSTEM

APERTURA VERTICALE OBLIQUA

I pensili con questo tipo di meccanismo necessitano per l'apertura di poco spazio libero sopra il mobile grazie al movimento basculante dell'anta che si apre senza difficoltà applicando poca forza anche in presenza di frontali pesanti. Con l'arresto progressivo le ante si fermano in qualsiasi posizione; in questo modo la maniglia è sempre facilmente raggiungibile. La chiusura è ammortizzata ed è possibile regolare la forza di tenuta in base al peso del frontale.

VERTICAL OPENING OBLIQUE

Wall units that mount this type of mechanism require little clearance above the cabinet thanks to the swivelling movement of the door that can be easily opened by applying slight pressure, even with heavy fronts. The doors stop in any position thanks to the gradual stopping movement; in this way, the handle is always easily accessible. The closing movement is cushioned and the closing force can be adjusted according to the weight of the front door.



**DI SERIE
STANDARD**



**MOTORIZZATO
SERVO-DRIVE
SERVO-DRIVE
MOTORISED
(Opz.007)**



	A	B	C	D
H 60	18	9,6	46,5	53,5
H 72	18	9,6	57	61

APERTURA VERTICALE

L'anta ad apertura verticale, potendo essere sollevata completamente verso l'alto, consente un accesso totale all'interno del pensile. Ideale per l'impiego in mobili a colonna per nascondere ad esempio apparecchi elettrici, o pensili con corpi mobili sovrastanti, ha la chiusura ammortizzata e la possibilità di regolare la forza di tenuta in base al peso del frontale.

VERTICAL OPENING

Doors with vertical opening movement can be fully raised to fully access the inside of the wall unit.

Ideal for use on column units to conceal electrical appliances for examples, or on wall units surmounted by mobile units.

The closing movement is cushioned and the closing force can be adjusted according to the weight of the front door.



**DI SERIE
STANDARD**



**MOTORIZZATO
SERVO-DRIVE
SERVO-DRIVE
MOTORISED
(Opz.007)**



	A	B	C	
H 36	34	23,5	34,5	
H 48	43	28,5	43,5	

PENSILE CON APERTURA ANTE A PACCHETTO

Il meccanismo d'apertura ante a pacchetto è idoneo sia sul pensile H 72 che H 96; la regolazione della forza di apertura può essere impostata in modo esatto in base ai pesi dei frontali, la chiusura è ammortizzata e la cerniera centrale clip si contraddistingue per l'innovativa tecnologia che garantisce la sicurezza per le dita.

WALL UNIT WITH LIFT-UP FOLDING DOOR

The lift-up folding door opening mechanism is suitable for wall units with H 72 or H 96; the opening force can be adjusted precisely according to the weight of the fronts, while the closing movement is cushioned and the central clip-on hinge features innovative technology for safeguarding the fingers.



H 72



H 96

DI SERIE STANDARD



	A	B	C
H 72	16,5	54	41
H 96	20	69	53

MOTORIZZATO SERVO-DRIVE SERVO-DRIVE MOTORIZED



SCHEMA MONTAGGIO LIMITATORE LIMITER INSTALLATION DIAGRAM

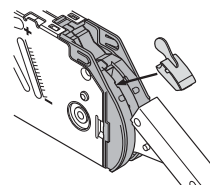

Per evitare l'interferenza dell'anta in fase di apertura con cornici o mensole, si può richiedere il limitatore dell'angolo di apertura cod. 5620005

In order to avoid that the door interferes with cornices or shelves during the opening movement, it is possible to request an opening angle limiter: code 5620005

PENSILI RIBALTA CHIUSURA BLUMOTION

FLAP DOOR WALL UNITS BLUMOTION CLOSING SYSTEM

PENSILE CON APERTURA A RIBALTA

Le ante aprendosi verso l'alto consentono di avere un' ampia visione d'insieme all'interno del mobile. In questo modo è possibile un comodo accesso agli oggetti contenuti al suo interno e, dal punto di vista ergonomico, molto vantaggioso. La regolazione della forza di apertura può essere impostata in modo esatto in base al peso del frontale. Grazie all'arresto progressivo le ante si fermano in qualsiasi posizione; in questo modo la maniglia è sempre facilmente raggiungibile. La chiusura è ammortizzata e un'unica manovra è sufficiente per regolare il frontale tridimensionalmente grazie all'assenza di cerniere e al sistema di aggancio clip.

WALL UNIT WITH FLAP DOOR

The doors that open upwards guarantee ample overall visibility inside the cabinet. In this way, all objects housed inside the cabinet can be comfortably accessed, making the system highly advantageous from an ergonomic perspective. The opening force can be adjusted precisely according to the weight of the front. The doors stop in any position thanks to the gradual stopping movement; in this way, the handle is always easily accessible. The closing movement is cushioned and a single manoeuvre is required to three-dimensionally adjust the front, thanks to the clip-on system and the absence of hinges.



DI SERIE STANDARD

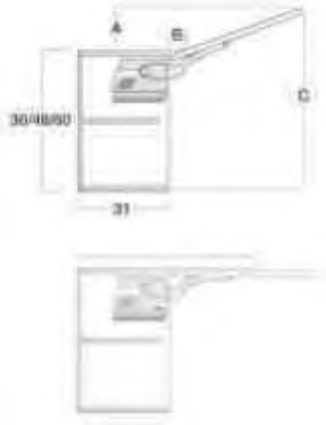

	A	B	C
H 36	11,5	3,5	37
H 48	15	3,5	49
H 60	18,5	3,5	61

Per evitare l'interferenza dell'anta in fase di apertura con cornici o mensole, si può richiedere il limitatore dell'angolo di apertura cod. 5620010

In order to avoid that the door interferes with cornices or shelves during the opening movement, it is possible to request an opening angle limiter: code 5620010

MOTORIZZATO SERVO-DRIVE SERVO-DRIVE MOTORIZED (Opz.007)



SCHEMA MONTAGGIO LIMITATORE PER RIBALTA H 36
FLAP DOOR LIMITER INSTALLATION DIAGRAM H 36

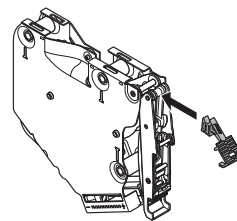

SCHEMA MONTAGGIO LIMITATORE PER RIBALTA H 48
FLAP DOOR LIMITER INSTALLATION DIAGRAM H 48

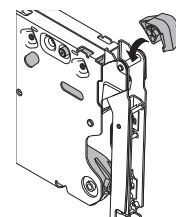

COLONNA 180 H 219 P 70,6 CON ANTE COMPLANARI

COLUMN 180 H 219 D 70,6 WITH SLIDING DOORS

COLONNA 180 H 219 P 70,6 CON ANTE COMPLANARI

Alla colonna da 180 P 60,6 H 219 si possono affiancare le colonne profondità 60,1 utilizzando a fine composizione il fianco di finitura come anta da 204x70,6

IMPIALLACCIATO sp. 2,4 codice 13904115 FASCIA "A" € 327 cadauno

IMPIALLACCIATO sp. 2,4 codice 13904115 FASCIA "B" € 422 cadauno

TELAIO LACCATO OPACO sp. 2,4 codice 13914115 FASCIA "A" € 233 cadauno

TELAIO LACCATO OPACO sp. 2,4 codice 13914115 FASCIA "B" € 254 cadauno

LACCATO OPACO sp. 2,4 codice 13924115 € 243 cadauno

LACCATO LUCIDO sp. 2,4 codice 13934115 € 362 cadauno

COLUMN 180 H 219 D 70,6 WITH SLIDING DOORS

Next to column 180, one can add a normal depth column 60,1 using a deeper finishing door 204x70,6 at the end of the composition

VENEERED th. 2,4 cod.13904115 "A" CATEGORY EACH € 327

VENEERED th. 2,4 cod.13904115 "B" CATEGORY EACH € 422

MATT LACQUERED FRAME th. 2,4 cod.13914115 "A" CATEGORY EACH € 233

MATT LACQUERED FRAME th. 2,4 cod.13914115 "B" CATEGORY EACH € 254

MATT LACQUERED th. 2,4 cod.13924115 EACH € 243

GLOSSY LACQUERED th. 2,4 cod.13934115 EACH € 362

Fianco di finitura
finishing side

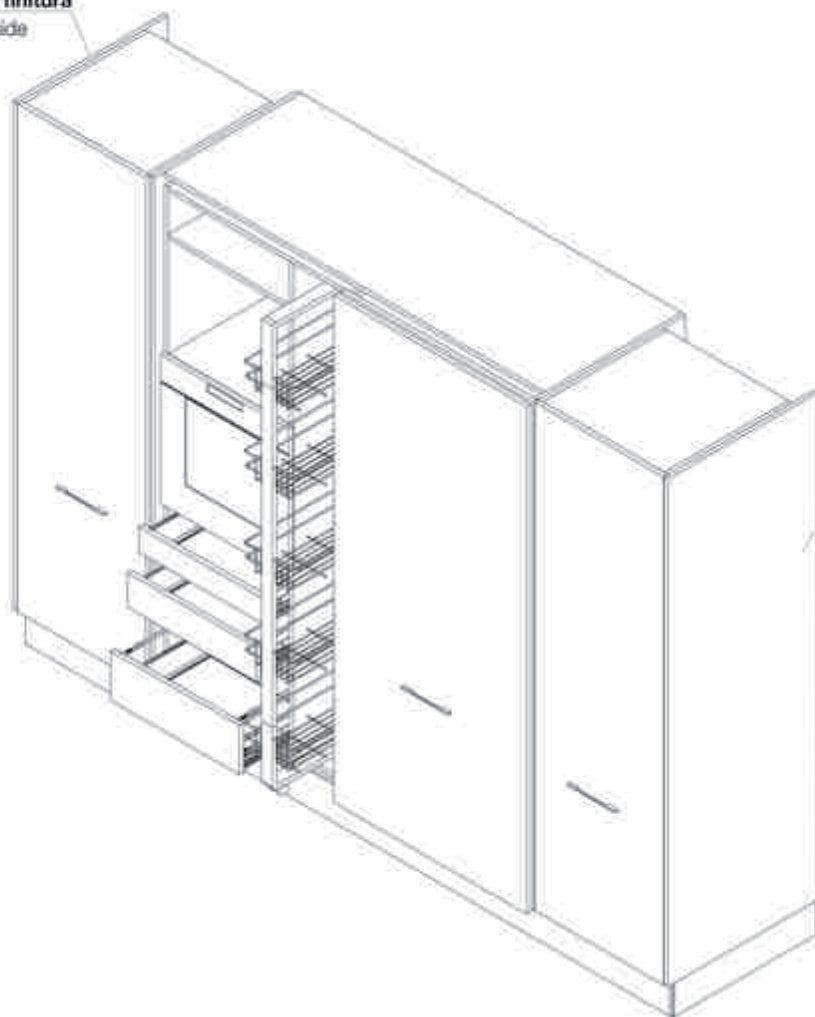

Fianco di finitura
finishing side

MODULARITÀ E COMPONENTIALITÀ MODULARITY AND FITTING SOLUTIONS

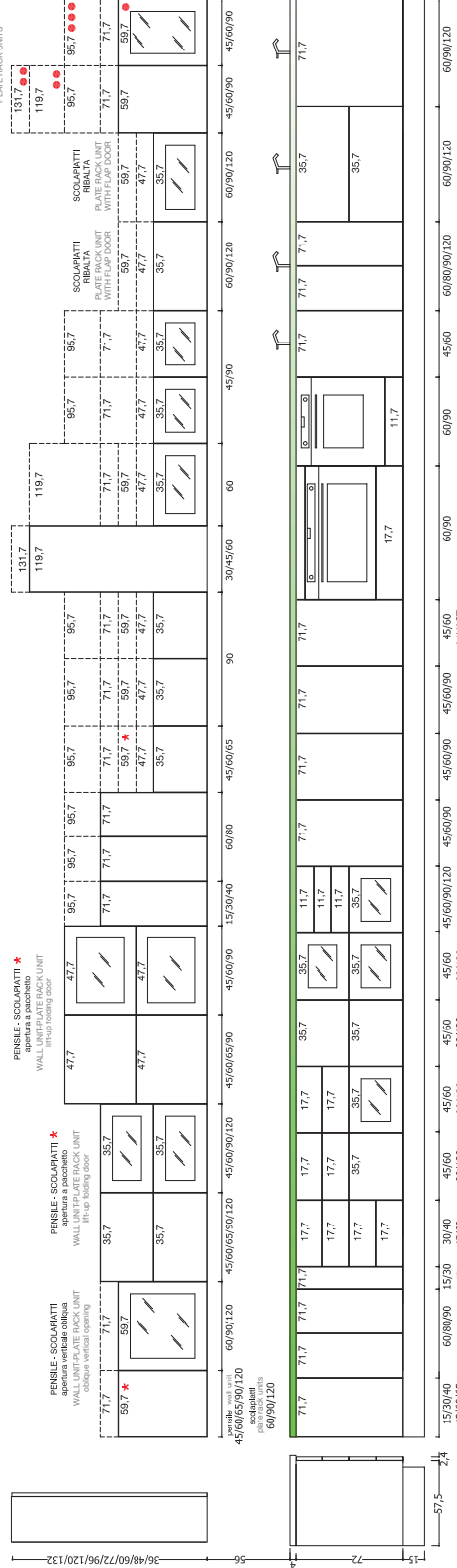

BASI H 75 PER TOP H 12
BASE UNITS H 75 FOR TOP H 12

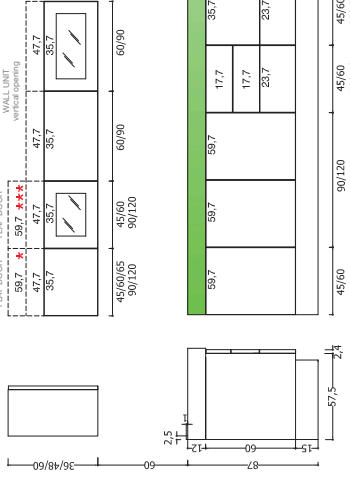

BASI SOSPENSE
HANGING-BASE UNITS

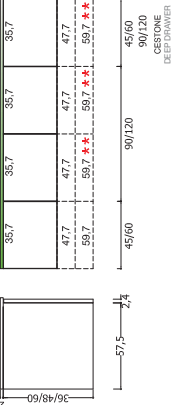

BASI LIVING
ROOM UNITS

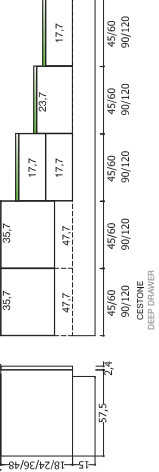

★ ESCLUSO 65 (WALL UNIT PLATE RACK UNIT - EXCLUDING 65)
 ★★ ESCLUSO 120 (WALL UNIT PLATE RACK UNIT - EXCLUDING 120)
 ★★★ ESCLUSO 130 (WALL UNIT PLATE RACK UNIT - EXCLUDING 130)

MODULARITÀ E COMPONENTIBILITÀ MODULARITY AND FITTING SOLUTIONS

gallery

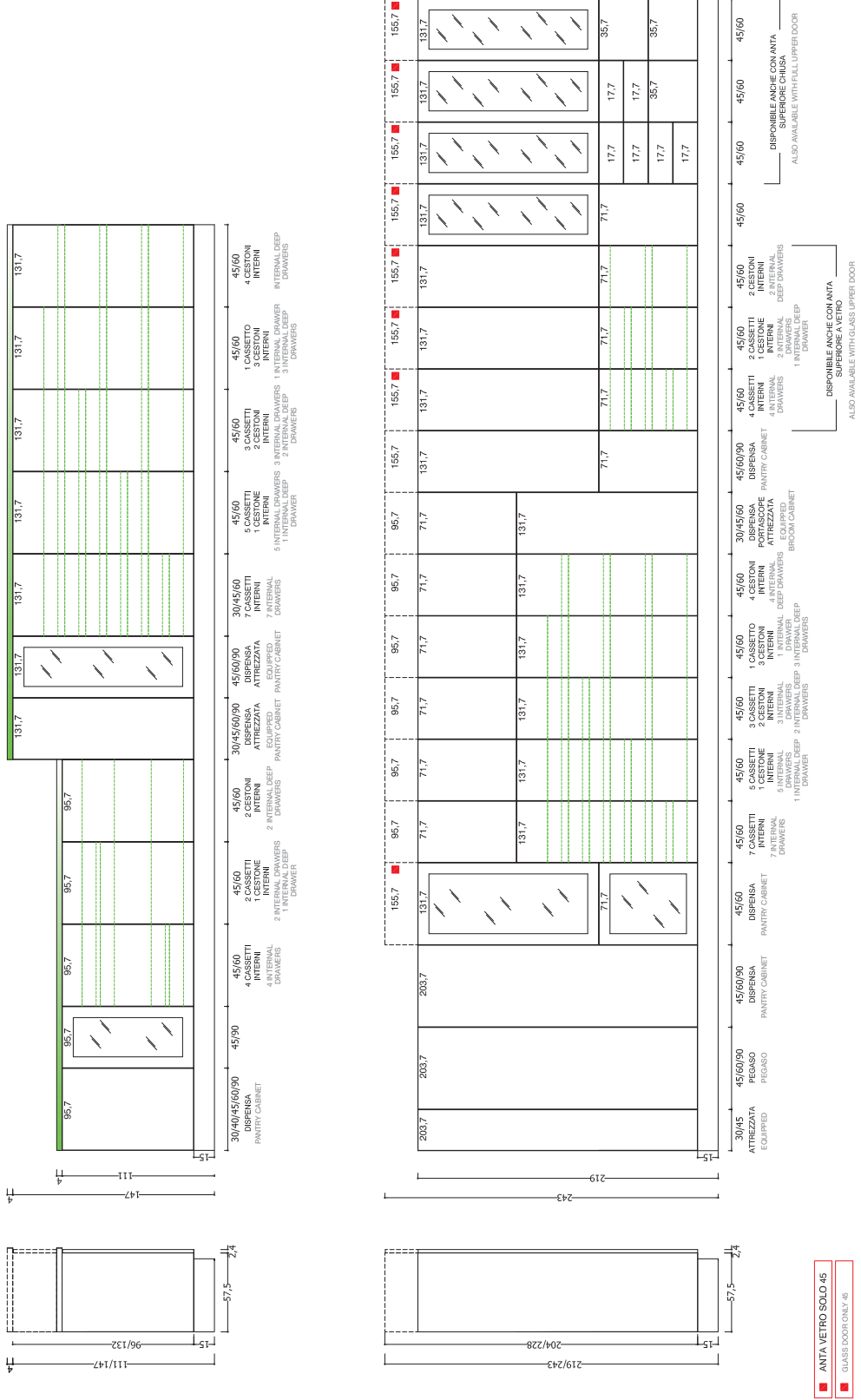

MODULARITÀ E COMPONIBILITÀ MODULARITY AND FITTING SOLUTIONS

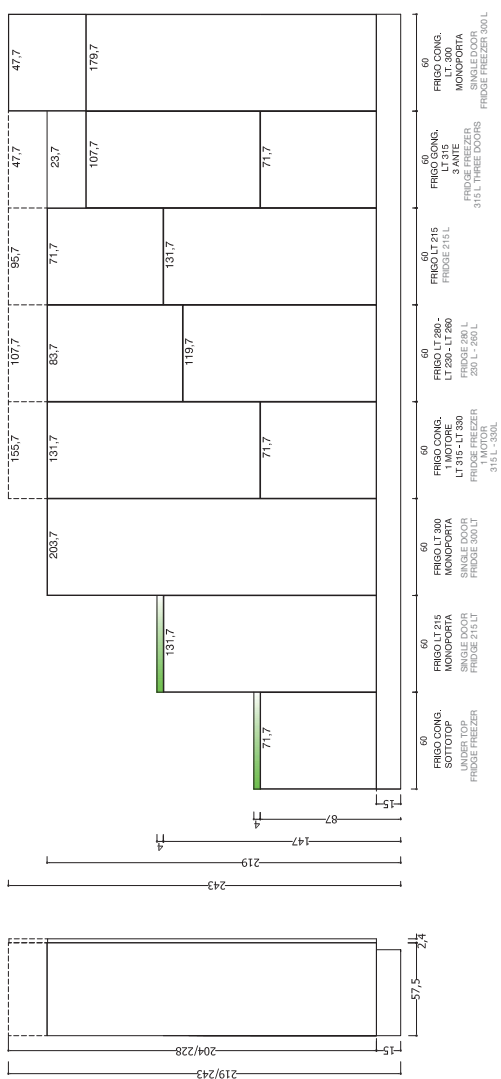

gallery

